

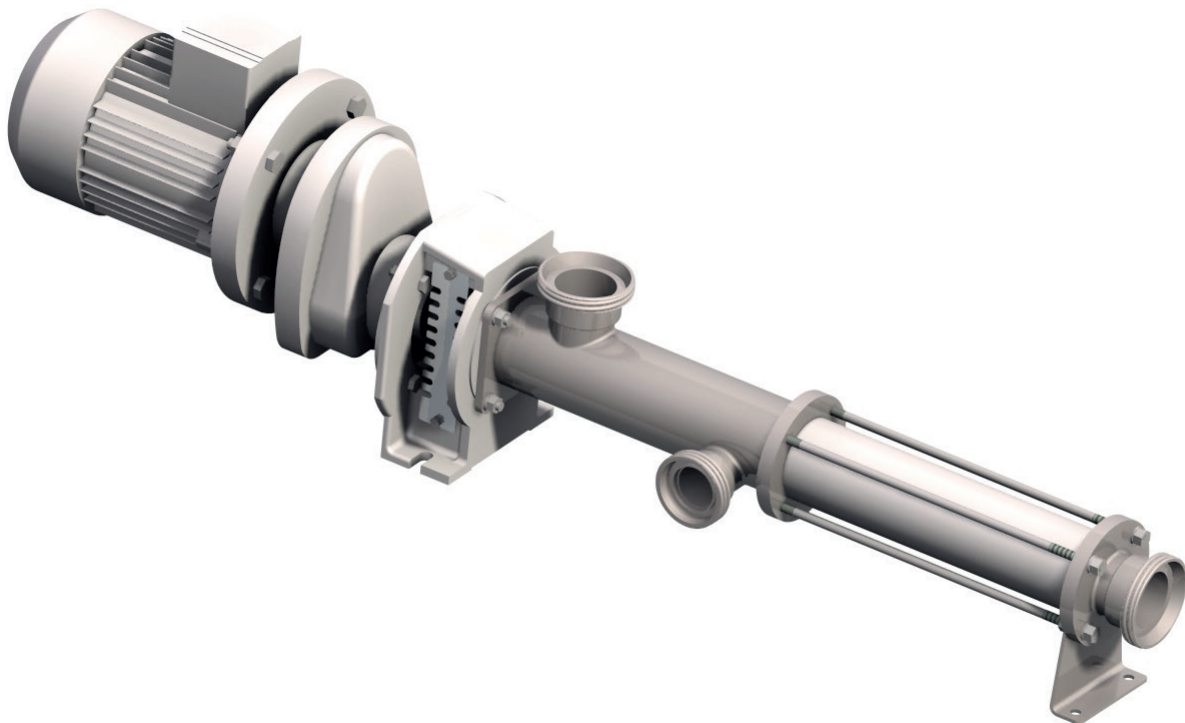

H Range - Hygienic grade



PROGRESSING CAVITY PUMP
Italian Designed & Manufactured

Legendary Reliability

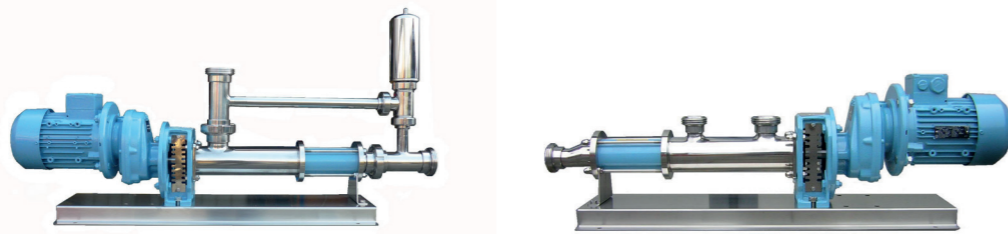

Features:

Hygienic:
We supply hygienic pumps, particularly designed to satisfy the most rigorous requirements and to avoid product contamination and spoiling.







Cleaning:
Manufactured free of any stagnation areas, the "H" range is available with clean in place system (CIP) and bypass ports.

Viscous Products:
For very concentrated viscous liquids, our hygienic models can work at low speeds and can be manufactured with enlarged inlets or with a hopper and an auger to convey the material into the pump.

Shear Sensitive Liquids:
The pumped product is always transferred gently. The progressive cavity pump principle doesn't generate a centrifugal action and there is no big changes in speed which would damage the product inexorably.

Material Selection:
Inside the company we produce the most important components of our pumps, this factor gives us the possibility to keep total control over the quality of the final product.

Markets:

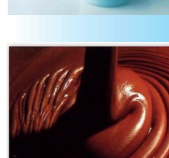
-  Dairy products
-  Beverages
-  Olive oils and fats
-  Fruit and vegetables
-  Beer and wine industry
-  Pharmaceutical and cosmetic industry
-  Candy, chocolate and sugar

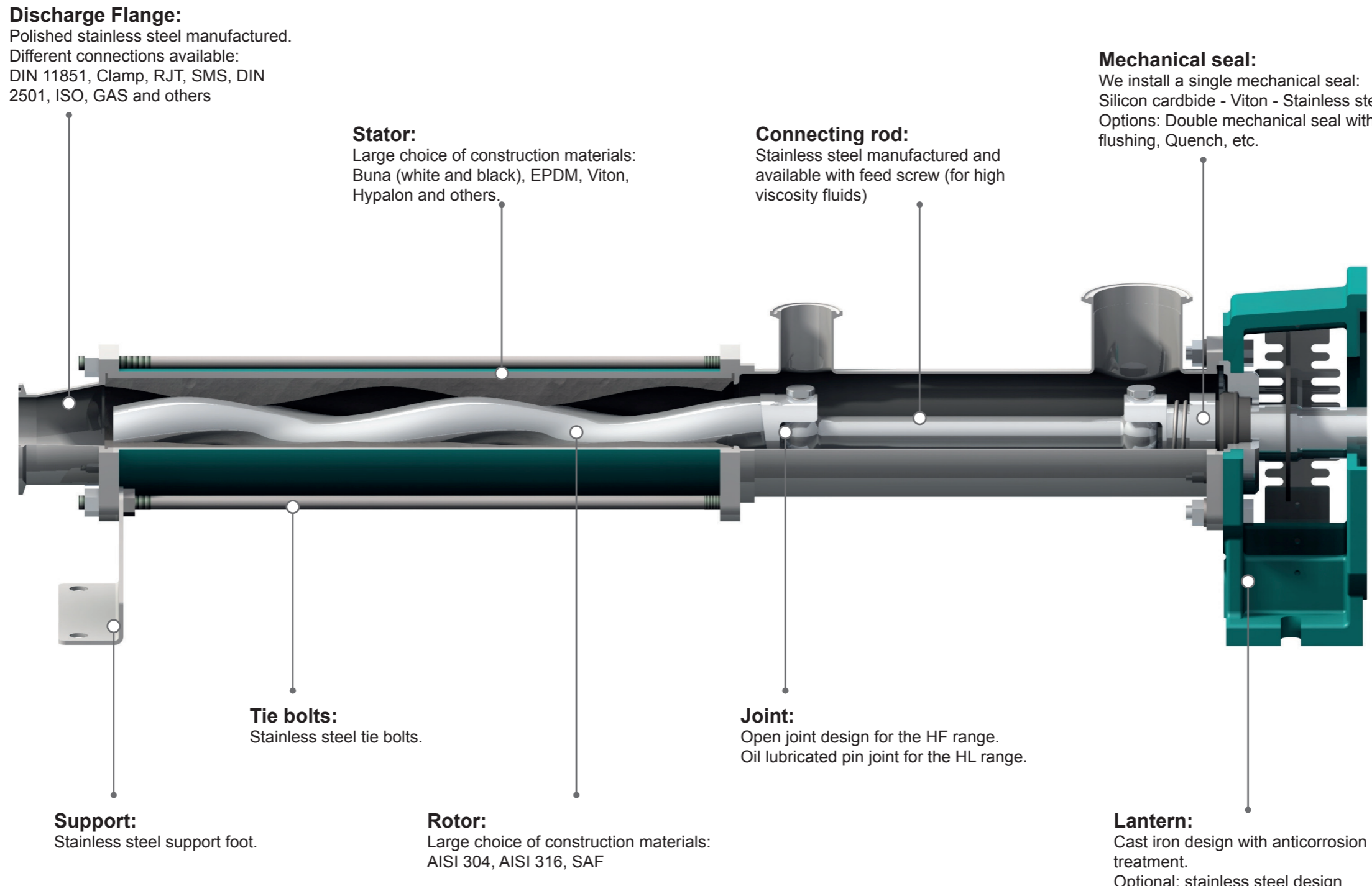



Your local authorized distributor:

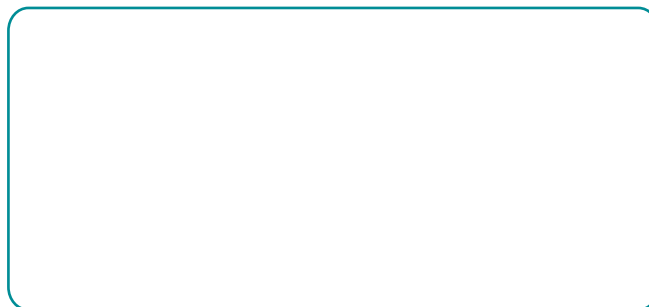

Sydex Srl
Via Lord Baden Powell 24
36045 Lonigo (VI) - Italia
Tel. 0039 0444 432588
Fax 0039 0444 432589
Web site: www.sydexpump.com
Email: info@sydexpump.com